Computer Controlled
PAN-TILT UNIT

Model PTU-D46

USER'S MANUAL

Version 2.14.0

Pan-Tilt Unit (Model PTU-D46) User's Manual, Version 2.14.0,
October 24, 2006

©1991,2006 by Directed Perception, Inc., 1485 Rollins Road,
Burlingame, California 94010, (650)342-9399, FAX: (650)342-
9199, URL: <http://www.DPerception.com>.

All rights reserved. Protected under U.S. Patents 5463432 and
5802412. No part of this book may be reproduced, stored in a
retrieval system, or transcribed, in any form or by any means,
electronic, mechanical, photocopying, recording, or otherwise,
without the prior written permission of Directed Perception, Inc.

The information in this manual is subject to change without notice
and, except for the warranty, does not represent a commitment on
the part of Directed Perception. Directed Perception cannot be held
liable for any mistakes in this manual and reserves the right to make
changes.

Table of Contents

Pan-Tilt User's Manual Version 2.14.0

1	INTRODUCTION	1
2	QUICK START.....	2
	2.1 Overview.....	2
	2.2 Installation Components	2
	2.3 Basic Setup Steps.....	3
3	INSTALLATION & INITIAL SETUP.....	4
	3.1 Power Source	4
	3.2 RS-232 Cable and Host Settings.....	5
	3.3 Initial Installation and Connections	6
	3.4 Basic Pan-Tilt Unit Commands	6
	3.5 Mounting Your Camera or Other Payload	7
4	COMMAND REFERENCE	8
	4.1 Binary Command Format	8
	4.2 General ASCII Command Format	8
	4.3 Positional Control Commands & Queries	8
	4.3.1 Position (absolute)	8
	4.3.2 Offset Position (relative offset).....	9
	4.3.3 Resolution per Position.....	9
	4.3.4 Limit Position Queries	10
	4.3.5 Position Limit Enforcement.....	10
	4.3.6 Immediate Position Execution Mode.....	11
	4.3.7 Slaved Position Execution Mode.....	11
	4.3.8 Await Position Command Completion	12
	4.3.9 Halt Command.....	12
	4.3.10 Monitor (Autoscan) Command.....	13
	4.4 Speed Control Commands & Queries.....	13
	4.4.1 Speed Control & Relevant Terms	13
	4.4.2 Speed (absolute).....	14
	4.4.3 Delta Speed (relative offset)	15
	4.4.4 Acceleration	15
	4.4.5 Base (Start-Up) Speed.....	16
	4.4.6 Speed Bounds	16
	4.4.7 Speed Control Modes.....	17
	4.5 Unit Commands	18
	4.5.1 Reset Pan-Tilt Unit	18
	4.5.2 Default Save/Restore	19
	4.5.3 Echo Query/Enable/Disable.....	19
	4.5.4 Feedback Verbose/Terse/Off.....	19
	4.5.5 Controller Firmware Version Query	20
	4.5.6 Outside Supply Voltage and Controller Temperature Query	20
	4.6 Power Control Commands & Queries	20
	4.6.1 Stationary Power Mode.....	21
	4.6.2 In-Motion Power Mode	21

Table of Contents

Pan-Tilt User's Manual Version 2.14.0

4.7	Host Serial Port and Control.....	22
4.7.1	Configuring Host Serial Port Baud and Communications.....	22
4.8	Step Modes.....	23
4.8.1	Configuring Step Mode.....	23
5	SPECIAL CONFIGURATIONS.....	24
5.1	High-Speed Operation	24
5.2	High-Payload Operation	24
5.3	Battery-Powered Operation	24
6	PTU OPTIONS.....	25
6.1	EIO Option: Expansion Serial Ports and Control	25
6.1.1	Select Serial Communications Target.....	25
6.1.2	Configuring Expanded Serial Port Communications.....	26
6.1.3	Attaching a Mouse/Trackball to an Expanded Serial Port.....	27
6.1.4	Expansion Analog Joystick Control Port and Pin-Out	27
6.1.4.1	Expansion Analog Joystick Commands	28
7	NETWORKING	30
7.1	Basic Networking Setup Steps.....	30
7.2	PTU Network Connections	30
7.3	PTU Network Software Commands	31
7.3.1	Unit Network ID	31
7.3.2	Unit Select/Deselect.....	32
	REGULATORY INFORMATION.....	35
	LIMITED WARRANTY	36

1 INTRODUCTION

The Computer-Controlled Pan-Tilt Unit from Directed Perception provides low-cost, fast and accurate positioning of cameras and other payloads. Some general features:

- Simple to command from any RS-232 terminal or computer
- Small form factor
- PTU-D46-17 performance highlights:
 - Load capacity over 6 lbs. (2.72kg)
 - Speeds over 300°/second
 - Resolution of 3.086 arc minute (.0514°)
- PTU-D46-70 performance highlights:
 - Load capacity over 9 lbs. (4.08kg)
 - Speeds over 60°/second
 - Resolution of .7714 arc minute (.0129°)
- Precise control of position, speed & acceleration
- On-the-fly position and speed changes
- Self calibration upon reset
- Power consumption can be controlled from host
- ASCII command mode for simplicity, binary commands available for efficient program control
- Constant current DMOS motor drives for increased performance and control
- DC power input from an unregulated source

The PTU-D46 series is electrically and software compatible with the earlier PTU-46 series. The PTU-D46 provides a smaller controller, higher payload capacity, greater power control, smoother movement, flash reprogrammability, and cooler operation for hot or more hostile environments.

Applications of the PTU include:

- Robotics & computer vision
- Webcam
- Security camera control
- Teleconferencing
- Advanced monitoring systems
- Tracking
- Photography, videography and special effects.

In addition, the PTU has flexible connectivity options.

This User's Manual provides information needed to set up and operate the PTU unit. The next section provides a quick overview to allow you to get started as quickly as possible. More detailed technical information is provided in the remaining sections.

2 QUICK START

2.1 Overview

As shown in Figure 1, the pan-tilt unit is connected to the pan-tilt controller. Power for the controller can be supplied from an optional AC/DC power supply or a battery power source. The pan-tilt controller accepts commands via RS-232 from a host computer, and it drives the position of the pan-tilt unit. A pan-tilt controller can be connected to other controllers via a multidrop RS-485 network so that a single host computer serial port can control multiple pan-tilt units.

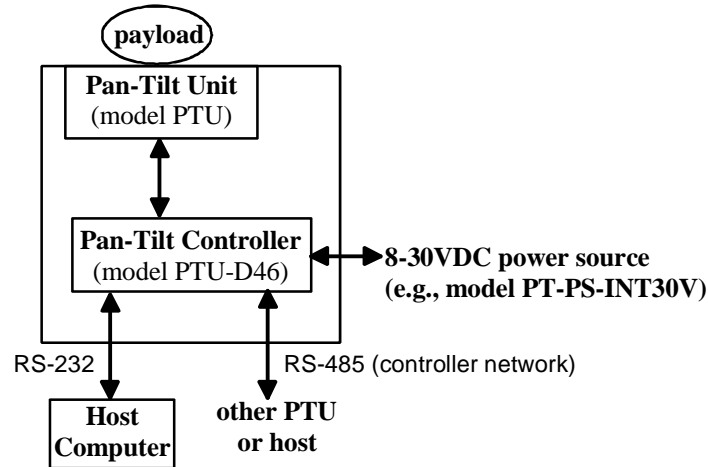

Figure 1: Pan-Tilt System Overview.

2.2 Installation Components

Components supplied with this manual are:

- Pan-Tilt Unit
- Pan-Tilt Controller
- Pan-Tilt Cable
- (optional) AC/DC Power Supply (model PT-PS-INT30V)
- (optional) C Programmer's Interface (model PTU-CPI)

Only move the pan-tilt axes using the knobs mounted on the pan-tilt unit motors. Manual rotation of pan-tilt axes (called backdriving) can degrade unit performance and accuracy.

2.3 Basic Setup Steps

The following outlines the basic pan-tilt set-up and installation steps. Section 3 details each of these steps.

1. Obtain a DC power source. The optional Pan-Tilt Power Supply (model PT-PS-INT30V) or an alternate power source may be used (see Sections 3.1 and 7).
2. An RS-232 cable is provided to connect your terminal or host computer to the Pan-Tilt Controller, and the host RS-232 setting must be set (see Section 3.2).
3. The pan-tilt unit should then be connected to power, the RS-232 host, and the controller. Pan-tilt operation can then be tested (See Section 3.3).
4. Section 3.4 describes some basic pan-tilt commands to get you going. Section 4 provides a full description of all pan-tilt unit commands and queries.
5. You can now mount your payload (e.g., camera) on the pan-tilt unit (see Section 3.5). Section 5 describes how to configure your pan-tilt for high speed operation.

3 INSTALLATION & INITIAL SETUP

This section describes the basic installation and setup steps required to get your pan-tilt operational as quickly as possible.

3.1 Power Source

A DC power source connects to the 2.1mm coaxial connector on the Pan-Tilt Controller. Two DC power source options are available:

- AC Source
- DC source: 9-30VDC (unregulated) capable of 17W continuous

To use an AC source, simply plug the optional Pan-Tilt Power Supply (model PT-PS-INT30V) connector to the controller and plug it into an AC power outlet.

Alternative power sources that can supply at least 17W continuous can be used by attaching a 2.1/5.5mm coaxial connector cable to a suitable DC power source (*e.g.*, battery power, vehicle power, or an AC/DC converter). In order to achieve the highest pan-tilt unit performance, use the highest motor voltage within the allowable range. To achieve the quietest pan-tilt operation, use a lower motor voltage (*e.g.*, 12VDC). Operation at 12VDC limits the highest unloaded pan-tilt speed to about 2/3 the rated maximum speed (*i.e.*, 200°/second for the PTU-D46-17, and 40°/second for the PTU-D46-70). Figure 2 shows the DC power connector wiring.

CAUTION! When wiring your own power source, failure to comply with wiring and power source requirements described in this manual can result in decreased unit performance or damage not covered under the limited warranty.

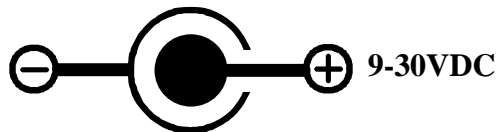

Figure 2: DC plug uses a 2.1/5.5mm connector

If you are providing your own DC power source, *the power source must never supply more than 3A of current, and if so, you must add a 3A Fast-Blow fuse in series with your DC power source.* For example, when connecting to a vehicle battery or lighter plug, you must fuse the incoming DC source. Failure to properly fuse your input power source could cause overloading of internal protection devices, pose a safety hazard, or void product warranties.

3.2 RS-232 Cable and Host Settings

An RS-232 terminal or host computer connects to the female DB-9 connector on the Pan-Tilt Unit Controller (PTU-C). The host terminal or computer should be set to 9600 baud, 1 start bit, 8 data bits, 1 stop bit, and no parity. Hardware handshaking and XON/XOFF are not used.

The RS-232 connections to the Pan-Tilt Controller female DB-9 are: TxD (pin 2), RxD (pin 3), and GND (pin 5). You will need to obtain a cable that connects the host RS-232 port to the controller DB-9 connector. Figure 3 shows cable configurations for some common computer hosts. Since TxD and RxD assignments to pins 2 and 3 can vary on host computers, try using a null modem if your initial connection does not work.

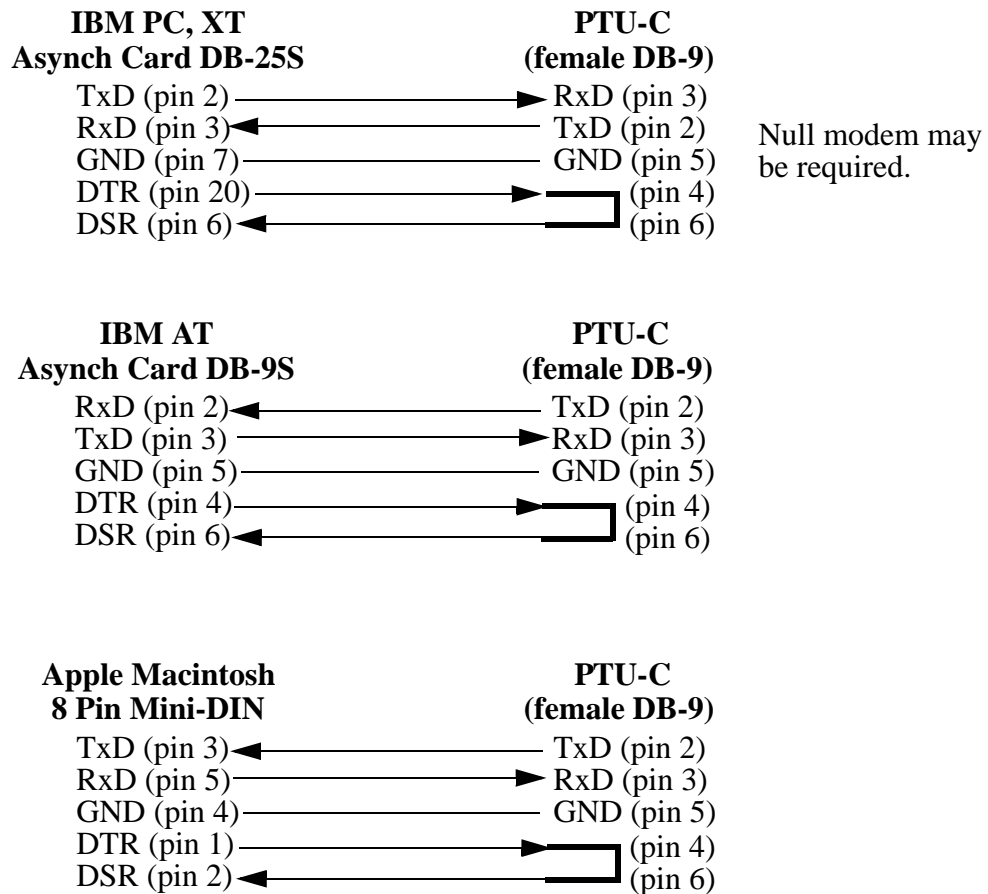

Figure 3: RS-232 Pan-Tilt Controller Connection to Common Hosts

3.3 Initial Installation and Connections

If you have the power source and RS-232 cables described in Sections 3.1 and 3.2, you are ready to connect the pan-tilt unit components together and test its operation. We suggest that you do not mount your payload (e.g., camera) until the initial installation is completed and tested.

1. Mount the Pan-Tilt Unit using standard #1/4-20 screws. The unit has two front and two bottom threaded holes. A camera tripod may be used for bottom mounting.
2. Connect the Pan-Tilt Unit to the Pan-Tilt Controller using the supplied cable. Note that the smaller cable connector attaches to the pan-tilt unit, and the larger cable connector attaches to the controller box. Securely screw the cable connectors to the pan-tilt unit and controller.

CAUTION! Failure to securely screw the supplied cable connectors to the pan-tilt unit and controller can cause damage to the controller when power is applied.

3. Connect the host terminal or computer to the Pan-Tilt Controller (PTU-C) using the RS-232 cable you supply (as described in Section 3.2). Configure the host RS-232 port as described in Section 3.2. For initial set-up, it is suggested that you use a terminal or terminal emulator on a host computer to become acquainted with the unit and its commands. For example, in Windows you can use HyperTerminal, and in UNIX there is TIP (terminal interface program).
4. You are now ready to power up the pan-tilt unit and test its operation. Plug the power plug into the pan-tilt controller PTU-C (see Section 3.1 for a discussion of power source options). Upon power up, introduction text should appear on your screen, and the pan-tilt unit should go through a reset cycle. This reset is completed when an asterisk ('*') appears. If the unit did not reset properly, recheck your power source and cabling. If the unit went through its reset procedure, but no text or garbled text appears on your screen, then:
 - Check that the host RS-232 host port settings are correct (see Section 3.2)
 - Check that the RS-232 cable is correct for your host (see Section 3.2)
5. You are now connected to the pan-tilt controller. Enter the character '?' for a complete listing of commands. The next section describes some basic commands to help you get going, and a full command description may be found in Section 4. We suggest that you exercise the unit and become familiar with its operation and commands before mounting your payload (e.g., camera) as described in Section 3.5.

3.4 Basic Pan-Tilt Unit Commands

Below are some pan-tilt commands that will familiarize you with the pan-tilt unit and its operation:

```
pp2500 *
tp-900 *
ps2500 *
pp0 *
```

This sets the pan axis to position 2500, the tilt axis to position -900, the pan speed to 2500 positions a second, and sets the pan position back home.

When operating the pan-tilt unit, the available command menu is printed when you enter the '?' character. A detailed description of pan-tilt commands and queries may be found in Section 4.

3.5 Mounting Your Camera or Other Payload

Your camera or other load attaches to the top mounting plate on the Pan-Tilt Unit. A centered hole and standard #1/4-20 bolt and nut is provided for simple mounting of cameras. Custom mounting is easily performed by removing the four hex screws holding the mounting plate, machining or drilling it to your requirements, and rescrewing the mounting plate back on the pan-tilt unit. The load will not interfere with the unit range of motion when the load does not extend below the base plate top.

Though the pan-tilt unit is rated to a maximum load of 4 lbs, the distribution of the load clearly affects the actual load capable of being moved by the pan-tilt unit. The steps to determine whether your load is within the maximum load capacity and dynamics are:

- Mount your load. Attempt to center the load's center of mass close to the hole in the mounting plate. Ensure that the load is securely attached to the mounting plate.
- First move the pan axis through its range to test whether the pan-tilt can handle the load (e.g., enter "**dr pp2700 a pp-2700 a pp0** "). A load that is too heavy or moved too quickly will cause the unit to lose synchrony, and this will be accompanied by an audible "rrrr" sound from the pan-tilt unit motors.
- If your load passed the pan axis load test, you can then test the tilt axis load handling capability. Because the tilt axis requires more power to move the load, it is more likely to lose synchrony for excessive loads or load weight distributions. Move the tilt axis through its range to test whether the pan-tilt can handle the load (e.g., enter "**dr tp-900 a tp600 a tp0** "). A load that is too heavy or moved too quickly will cause the unit to lose synchrony, and this will be accompanied by an audible "rrrr" sound from the pan-tilt unit motors.
- If your load fails the above pan or tilt axis load handling tests, contact Directed Perception for further assistance.
- If your load passes the above pan and tilt axis load handling tests, you are ready to begin controlling your load using the commands describe in Section 4.
- The initial pan-tilt unit parameters ensure the highest load movement torque that can be generated from the pan-tilt unit. Significantly faster or lower power control can be obtained via commands to the pan-tilt unit. The speed and acceleration of a mechanical system depends upon the inertial properties of your load. The ability of the pan-tilt unit to successfully move your load without losing synchrony depends upon the inertial load factors and their relationship to power supply voltage, unit speed, acceleration, position, motor torque, etc. Section 5 discusses how to configure pan-tilt parameters to achieve more optimal pan-tilt unit performance for your load.

4 COMMAND REFERENCE

This section describes the pan-tilt unit command set. Each command has a section that provides a brief functional description, a format (syntax) description, examples, and related topics. When controlling the pan-tilt unit from a terminal, a complete menu of pan-tilt commands can be obtained by entering the character “?”.

4.1 Binary Command Format

A C Programmer's Interface (model PTU-CPI) is available for higher bandwidth binary communications between a host computer and the PTU controller.

4.2 General ASCII Command Format

When describing the format (syntax) of pan-tilt commands, the following conventions are adopted:

- Commands issued to the pan-tilt unit (e.g., typed in by you) are shown in bold.
- Input characters may be in upper or lower case (we show them in upper case for presentational consistency)
- A delimiter (<delim>) can be either a space (“ ”) or a carriage return (<CR>).
- A successfully executed command returns “* <CR>”. Successful query execution returns “* <QueryResult><CR>”. Command execution failure returns “! <ErrorMessage><CR>”. A pan axis limit hit asynchronously returns “! P” and a tilt axis limit hit asynchronously returns “! T”.

4.3 Positional Control Commands & Queries

4.3.1 Position (absolute)

Description:

Specify or query the absolute pan or tilt axis position. Desired positions can be changed on-the-fly without waiting for previous position commands to complete.

Syntax

Query current absolute pan position:	PP<delim>
Set desired absolute pan position:	PP<position><delim>
Query current absolute tilt position:	TP<delim>
Set desired absolute tilt position:	TP<position><delim>

Example

The following sends the pan axis to the left, waits, then sends it to the right:

```

PP-2500 *
A *
PP * Current Pan position is -2500
PP2500 *
A *
PP * Current Pan position is 2500

```

Related Topics

- Position (relative offset and desired position queries): See Section 4.3.2
- Position resolution (units): See Section 4.3.3
- Position limits: See Section 4.3.4
- Position execution modes: See Sections 4.3.6, 4.3.7 and 4.3.8
- Position limit enforcement modes: See Section 4.3.5

4.3.2 Offset Position (relative offset)

Description

Specify desired axis position as an offset from the current position, or Query the current axis position. Desired offset positions can be changed on-the-fly without waiting for previous position commands to complete.

Syntax

Query desired pan position: **PO<delim>**
 Set desired offset pan position: **PO<position><delim>**
 Query desired tilt position: **TO<delim>**
 Set desired offset tilt position: **TO<position><delim>**

Example

The following sends the pan axis to position -500, then sends it 1500 positions to the left:

```
PP-500 *
A *
PO * Current Pan position is -500
PO1500 *
A *
PP * Current Pan position is 1000
```

Related Topics

- Position resolution (units): See Section 4.3.3
- Position limits: See Section 4.3.4
- Position execution modes: See Sections 4.3.6, 4.3.7 and 4.3.8
- Position limit enforcement modes: See Section 4.3.5

4.3.3 Resolution per Position

Description

Query returns the axis resolution per position moved (in seconds/arc).

Syntax

Query pan resolution: **PR<delim>**
 Query tilt resolution: **TR<delim>**

Example

Resolution can be determined by:

```
PR * 185.1428 seconds arc per Pan position
1 sec arc = 1/(60 min arc * 60 sec arc) = .0002778°. So 185.1428 seconds arc
equals (185.1428 sec arc * .0002778°) = 0.0514285°. Thus, to pan 21.3° left
requires a relative move of (21.3°/0.0514285°) ≈ 414 positions, yielding the
following command:
```

```
PO414 *
```

Related Topics

- Factory options are available to achieve higher resolution or accuracy.

4.3.4 Limit Position Queries

Description

Queries return the axis position bounds determined upon unit reset.

Syntax

```
Query minimum pan position:  PN<delim>
Query maximum pan position:  PX<delim>
Query minimum tilt position:  TN<delim>
Query maximum tilt position:  TX<delim>
```

Example

```
R *
PN * Minimum Pan position is -3090
PX * Maximum Pan position is 3090
TN * Minimum Tilt position is -907
TX * Maximum Tilt position is 604
LE *
PP3200 ! Maximum allowable Pan position is 3090
```

Related Topics

- Position resolution (units): See Section 4.3.3
- Achieving larger axis bounds: See Section 4.3.5

4.3.5 Position Limit Enforcement

Description

Determines whether position commands beyond the detected pan and tilt axis limits are allowable. The default is position limits are enabled (i.e., enforced).

Enabling position limits ensures that all positions within the limits can be achieved when the load does not extend below the bottom of the load mounting plate (see Section 3.5). When limits are enabled, commands outside of the limits return an error message and are not executed. In enabled limit mode, limits are only be reached when the unit has lost synchrony and this error condition requires a unit reset (see Section 4.5.1). When a limit is reached either “!P” or “!T” is printed to indicated which axis limit was hit (pan or tilt).

When larger operational ranges are required, the limits may be disabled. Positional commands outside the limits are not rejected when limits are disabled. Positions outside the limits introduce the possibility that the tilt axis and load can interfere with the pan axis, so it is important that accessibility of positions outside the limits be determined.

Syntax

```
Query the current position limit mode:  L<delim>
Enable position limits:                 LE<delim>
Disable position limits:                 LD<delim>
```

Example

```

L * Limit bounds are ENABLED (soft limits enabled)
PX * Maximum Pan position is 3090
PP3200 ! Maximum allowable Pan position is 3090
LD *
PP3200 *
A *
PP * Current Pan position is 3200

```

Related Topics

- Position commands: See Sections 4.3.1 and 4.3.2

4.3.6 Immediate Position Execution Mode

Description

Instructs pan-tilt unit to immediately execute positional commands. This is the default mode.

Syntax

I<delim>

Example

For the below commands, the pan axis will immediately execute the pan position command:

```

I *
PP1000 *

```

Related Topics

- Alternative slaved position execution mode: See Section 4.3.7

4.3.7 Slaved Position Execution Mode

Description

Instructs pan-tilt unit to execute positional commands only when an Await Position Command Completion command is executed (see Section 4.3.8) or when put into Immediate Execution Mode (see Section 4.3.6). This mode is useful when coordinated pan and tilt axis movements are desired.

Syntax

S<delim>

Example

The following commands change the position execution mode, instruct the axes which position to achieve, and an await command causes the position commands to be executed simultaneously:

```

DR *
S *
PP1500 *
TP-900 *
PP * Current Pan position is 0
TP * Current Tilt position is 0
A *
PP * Current Pan position is 1500
TP * Current Tilt position is -900

```

Related Topics

- Alternative immediate position execution mode: See Section 4.3.6

4.3.8 Await Position Command Completion

Description

Awaits the completion of the last issued pan and tilt axis position commands. Used to coordinate axis motions.

Syntax

A<delim>

Example

The following commands instruct the pan axis to move to a position, then move to another position:

```
I *
PP * Current Pan position is 0
PP2000 *
A *
PP * Current Pan position is 2000
PP0 *
A *
PP * Current Pan position is 0
```

In contrast, the following commands would begin to move to the first position, and before that position is reached, the next position would be moved towards (this is often called an on-the-fly position change):

```
I *
PP * Current Pan position is 0
PP2000 *
PP0 *
```

Related Topics

- This command can be used for both the Immediate Position Execution Mode (see Section 4.3.6) and Slaved Position Execution Mode (see Section 4.3.7)

4.3.9 Halt Command

Description

Immediately decelerates and halts pan-tilt movement.

Syntax

Halt all pan-tilt movement:	H<delim>
Halt pan axis movement:	HP<delim>
Halt tilt axis movement:	HT<delim>

Example

```
PP2500 *
A *
PP-2500
```

Then while the pan-tilt is moving, the host decides to stop immediately :

```
H *
```

Related Topics

- This command can be used for both the Immediate Position Execution Mode (see Section 4.3.6) and Slaved Position Execution Mode (see Section 4.3.7)

4.3.10 Monitor (Autoscan) Command

Description

Command defines and initiates repetitive monitoring (scanning) of the pan-tilt. Autoscanning is immediately terminated upon receipt of a character from the host computer, and the pan-tilt is sent to its home position.

Syntax

Initiate monitor (autoscan) in pan axis only:

M<pan pos 1>,<pan pos 2><delim>

Initiate monitor (autoscan) in both pan and tilt axes:

M<pan pos 1>,<pan pos 2>,<tilt pos 1>,<tilt pos 2><delim>

Initiate last defined monitor (autoscan) command (the default at power up is pan axis only autoscan between the pan limit positions):

M<delim>

Enable monitor (autoscan) at power up: **ME**<delim>

Disable monitor (autoscan) at power up: **MD**<delim>

Query monitor status at power up: **MQ**<delim>

Example

When executed at power up,

M *

the pan-tilt begins scanning between the minimum and maximum pan limit positions.

<delim>

terminates the scanning and homes the pan-tilt. Other monitoring command forms:

M-2500,100 *

M-2500,100,-800,600 *

M0,0,-300,300 *

Related Topics

- Limit Position Queries (see Section 4.3.4)

4.4 Speed Control Commands & Queries

4.4.1 Speed Control & Relevant Terms

The Pan-Tilt Unit provides for precise control of axis speed and acceleration. This subsection briefly describes how speed control is performed and it introduces relevant terms.

As shown in Figure 4, *upper* and *lower speed limits* determine the bounds on nonstationary pan-tilt velocities. The *base (start-up) speed* specifies the velocity at which the pan-tilt axis can be started from a full stop without losing synchrony (as described in Section 3.5), and it is more a function of the motors rather than load characteristics. Due to base speed requirements and the property that motors lose torque as speed increases, acceleration is required to achieve axis speeds above the base rate. The pan-tilt controller uses trapezoidal acceleration and deceleration for speeds above the base rate and less than the maximum allowed speed. Figure 4 shows two acceleration cases. In the first, an axis accelerates up to a desired constant speed (*slew rate*), then decelerates. The second case shows the case when the unit does not have sufficient time to accelerate up to the desired slew speed before the need to decelerate to the desired position.

The pan-tilt controller provides for on-the-fly position and speed changes. If the direction is changed on-the-fly, the controller manages all deceleration, direction reversal, and acceleration to achieve the most recently specified target pan-tilt speed and acceleration rates.

Because speed, acceleration, and position are precisely controlled, you can accurately and simply predict the position attained by the pan-tilt unit in time.

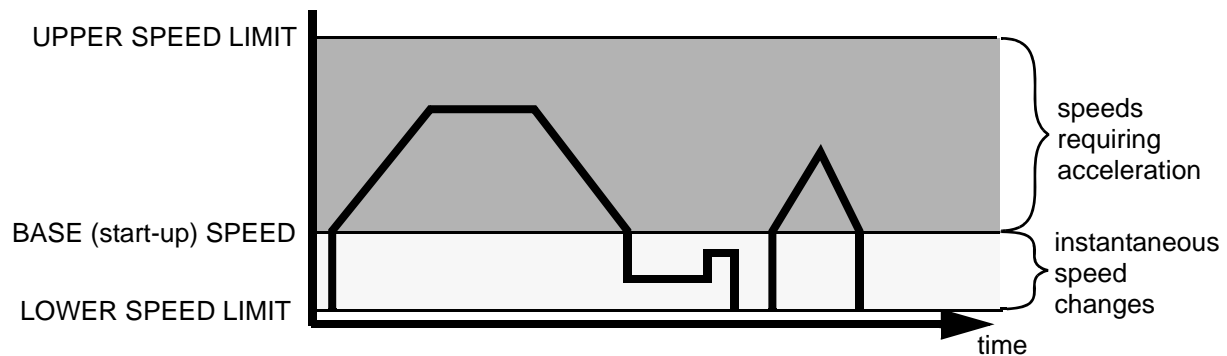

Figure 4: Axis Speed, Instantaneous Speeds, Trapezoidal Acceleration, and On-The-Fly Speed and Position Changes

4.4.2 Speed (absolute)

Description

Specify or query desired axis speed. Desired speed is specified in positions/second and it can be changed on-the-fly. The speed specifies that rate at which the pan-tilt move to achieve position movement commands.

Desired speed commands outside the speed bounds return an error and are not executed.

Syntax

Query desired pan speed:	PS<delim>
Set desired pan speed:	PS<positions/sec><delim>
Query desired tilt speed:	TS<delim>
Set desired tilt speed:	TS<positions/sec><delim>

Example

The following commands instruct the pan axis to move to the far left, then slowly move right, and then on-the-fly it speeds up:

```
I *
PS2500 *
PP2600 *
A *
PS600 *
PP-2600 *
PS2500 *
```

Related Topics

- Position commands: See Section 4.3.1 - 4.3.2
- Position resolution (units): See Section 4.3.3
- Speed bounds: See Section 4.4.6

4.4.3 Delta Speed (relative offset)

Description

Specify desired axis speed as an offset from the current speed, or Query the current axis speed. Desired delta (offset) speed is specified in positions/second and it can be changed on-the-fly. A desired delta speed command that results in a speed outside the legal speed bounds returns an error and it is not executed.

Syntax

Query current pan speed: **PD<delim>**
 Set desired delta (offset) pan speed: **PD<positions/sec><delim>**
 Query current tilt speed: **TD<delim>**
 Set desired delta (offset) tilt speed: **TD<positions/sec><delim>**

Example

The following commands instruct the pan axis to move to the far left, then slowly move right, and then on-the-fly it decreases speed by -150 positions/second, then queries the current speed:

```
I *
PS2500 *
PP2600 *
A *
PS600 *
PP-2600 *
PD-150 *
PD * Current Pan speed is 520 positions/sec
```

Related Topics

- Position commands: See Section 4.3.1 - 4.3.2
- Position resolution (units): See Section 4.3.3
- Speed bounds: See Section 4.4.6

4.4.4 Acceleration

Description

Specify or query axis acceleration and deceleration for speeds above the base speed. Acceleration is specified in positions/second².

Syntax

Query desired pan acceleration: **PA<delim>**
 Set desired pan acceleration: **PA<positions/sec²><delim>**
 Query desired tilt acceleration: **TA<delim>**
 Set desired tilt acceleration: **TA<positions/sec²><delim>**

Example

The following illustrate different rates of acceleration:

```
PA * Pan acceleration is 2000 positions/sec^2
PB * Current Pan base speed is 1000 positions/sec
PU * Maximum Pan speed is 2902 positions/sec
PP0 *
PS2900 *
PP2600 *
PA8000 *
PP0 *
```

Related Topics

- Position resolution (units): See Section 4.3.3
- Symmetric trapezoidal acceleration is used, so the rate of deceleration is equivalent to the rate of acceleration
- Acceleration cannot be changed on-the-fly since it takes several seconds to recompute the internal tables used to rapidly execute speed ramping.

4.4.5 Base (Start-Up) Speed

Description

Specify or query axis base (start-up) speed. Base speed is specified in positions/second. Defaults to 1000 positions/sec.

Syntax

```
Query desired pan base speed:  PB<delim>
Set desired pan base speed:    PB<positions/sec><delim>

Query desired tilt base speed: TB<delim>
Set desired tilt base speed:   TB<positions/sec><delim>
```

Example

The following commands home the pan axis, moves it far left, changes the base rate, then moves back to home:

```
I *
PP0 *
A *
PP2600 *
PB * Current Pan base speed is 1000 positions/sec
PB1000 *
PP0 *
```

Related Topics

- Position resolution (units): See Section 4.3.3
- Acceleration: See Sections 4.4.1 and 4.4.4
- Speed bounds: See Section 4.4.6
- Changes in the base rate cannot be made on-the-fly since it takes several seconds to recompute the internal tables used to rapidly execute speed ramping.

4.4.6 Speed Bounds

Description

Set and query the upper and lower speed bounds for desired speed commands.

Syntax

```
Query upper pan speed limit:  PU<delim>
Set upper pan speed limit:    PU<positions/sec><delim>

Query lower pan speed limit:  PL<delim>
Set lower pan speed limit:    PL<positions/sec><delim>
```

```

Query upper tilt speed limit:  TU<delim>
Set upper tilt speed limit:   TU<positions/sec><delim>

Query lower tilt speed limit:  TL<delim>
Set lower tilt speed limit:   TL<positions/sec><delim>

```

Example

```

PU * Maximum Pan speed is 2902 positions/sec
PS3300 ! Pan speed cannot exceed 2902 positions/sec
PS2900 *
PL * Minimum Pan speed is 31 positions/sec
PL20 ! Motor speed cannot be less than 31 pos/sec
PL40 *

```

Related Topics

- Position resolution (units): See Section 4.3.3
- Changes in the upper speed limit cannot be made on-the-fly since it takes several seconds to recompute the internal tables used to rapidly execute speed ramping.

4.4.7 Speed Control Modes

Description

By default, position control commands are independent from the speed control commands. In this *independent control mode*, the commanded speed is an unsigned magnitude that determines the speed at which independently commanded positions are effected, and the execution of these speed commands do not affect the commanded desired positions themselves. This mode is appropriate for pure position control methods (when pan-tilt control is effected solely by commanding pan-tilt position) and hybrid position-velocity control methods (when pan-tilt positions and the rate at which they are achieved are both controlled).

An alternative pan-tilt control method uses a *pure velocity control mode* in which all pan-tilt control is effected by signed changes in command axis speed. In this mode, the speed command specifies a signed velocity in which the sign determines the direction of axis movement, and the ordinal value specifies the speed of movement in this direction. In this mode, if the commanded speed is negative, the axis is automatically commanded to the minimum axis position. Conversely, if the speed command is positive, the axis is automatically commanded to the maximum axis position. A speed of zero is applied by halting the axis motion. *It is important to note that that in pure velocity control mode, a speed command for a given axis effectively overrides currently executing position commands.* As a result, the speed control mode at power up is always set to independent control mode; the speed control mode is not saved as defaults that are preserved when the unit is powered back up.

These commands are available in PTU firmware versions 1.09.7 and higher.

Syntax

```

Query the current speed control mode:  C<delim>
Set to independent control mode (default): CI<delim>
Set to pure velocity control mode:    CV<delim>

```

Example

Put into the default independent control mode, the pan-tilt will finish at position -3000. Put in the pure velocity control mode, the pan-tilt will finish on the opposite pan side. Note that the default restore (also executed upon unit power up) restores the unit to independent control mode:

```

CI *
PP-3000 *
PS1000 *
A *
CV *
PP-3000 *
PS1000 *
DR *
PP-3000 *
PS1000 *

```

Related Topics

- Position commands: See Section 4.3.1-4.3.2
- Speed commands: See Section 4.4.2-4.4.3

4.5 Unit Commands

4.5.1 Reset Pan-Tilt Unit

Description

This command controls how, and when, the pan-tilt unit is calibrated. By default, the pan-tilt unit is configured to reset both the pan and tilt axes automatically upon power up and by issuing the reset command.

The reset mode commands are used to control the reset performed at pan-tilt power up, and to allow reset of an individual pan-tilt axis. The reset calibration allows the pan-tilt unit to determine axis coordinates, hence *a pan-tilt axis should be reset prior to issuing any axis position commands*. A pan-tilt axis that has not been calibrated has a minimum and maximum axis position of 0 (see Section 4.3.4), hence position commands in limit enabled mode (see Section 4.3.5) will return an illegal position command feedback.

Syntax

Performs Reset calibration: **R<delim>**

Reset modes (saved in internal EEPROM for power up reset control):

```

Disable reset upon power up: RD<delim>
Reset tilt axis only: RT<delim>
Reset pan axis only: RP<delim>
Reset both pan and tilt axes upon power up: RE<delim>

```

Example

```

RT *
R *
RP *
R *
RD *
R *
RE *
R *

```

Related Topics

- A load beyond the handling capacity of the pan-tilt unit may cause the reset to fail, so load handling capability should be tested as described in Section 3.5.

4.5.2 Default Save/Restore

Description

Allows current axis settings to be saved as defaults that are preserved when the unit is powered back up. Also allows the factory defaults to be restored.

Syntax

```

Save current settings as defaults:  DS<delim>
Restore stored defaults:           DR<delim>
Restore factory defaults:          DF<delim>

```

Related Topics

- Defaults are saved in EEPROM which have a lifetime limit on the number of writes before memory failure. Though it is unlikely that these failure limits will be reached, excessive saving of current defaults should be avoided when possible.

4.5.3 Echo Query/Enable/Disable

Description

Sets of queries whether the pan-tilt controller echoes incoming commands from the host.

Syntax

```

Query current echo mode:           E<delim>
Enable host command echoing:       EE<delim>
Disable host command echoing:      ED<delim>

```

Example

```

PP * 22
ED *
<pp entered again, but not echoed>* 22

```

4.5.4 Feedback Verbose/Terse/Off

Description

Command and query the ASCII feedback returned by PTU commands.

Syntax

```

Enable verbose ASCII feedback:      FV<delim>
Enable terse ASCII feedback:       FT<delim>
Query ASCII feedback mode:         F<delim>

```

Example

```

FV *
PP * Current pan position is 0
FT *
PP * 0
F * ASCII terse mode

```

4.5.5 Controller Firmware Version Query**Description**

Query specifies the version and copyrights for the pan-tilt controller firmware.

Syntax

```
V<delim>
```

Example

```
V * Pan-Tilt Controller v2.12.1d1(C14/E), (C)2003 Directed Perception, Inc., All
Rights Reserved
```

4.5.6 Outside Supply Voltage and Controller Temperature Query**Description**

The D46 hardware includes sensors for the internal case temperature and the input voltage supplied to the controller power receptacle. This query measures and prints the controller temperature and input supply voltage.

Syntax

```
O<delim>
```

Example

```
O * Input 30 VDC @ 86 degF
```

4.6 Power Control Commands & Queries

A key advantage of the constant current motor control drivers used in the Pan-Tilt Controller is that it allows the current consumed by the pan-tilt unit to be controlled via simple unit commands. These capabilities are useful for battery powered operation (see Section 7), reducing unit heat generation, and extending the rated life of the motor driver circuitry.

4.6.1 Stationary Power Mode

Description

Set and query the current level applied to axis motors when not in-transit.

Syntax

Query pan hold power mode:	PH<delim>
Regular pan hold power mode:	PHR<delim>
Low pan hold power mode:	PHL<delim>
Off pan hold power mode:	PHO<delim>
Query tilt hold power mode:	TH<delim>
Regular tilt hold power mode:	THR<delim>
Low tilt hold power mode:	THL<delim>
Off tilt hold power mode:	THO<delim>

Example

```
PH * Pan in REGULAR hold power mode
PHL *
PH * Pan in LOW hold power mode
```

Related Topics

- Because holding torque for steppers is significantly greater than generated dynamic torque, it is highly recommended that Low Hold Power Mode be used when appropriate for your load. Regular hold power is intended to be used for brief periods when very high holding torque may be required; this requirement is rare. Regular hold power mode should be avoided or used sparingly, as its use for long periods of time can lead to significant motor and controller heating (depending on ambient temperature).
- When using Off Hold Power Mode, fully test that your load does not backdrive the unit when stationary. Backdriving will cause the controller to lose track of pan-tilt position, and this requires that the unit be reset (see Section 4.5.1). Backdriving is more likely on the tilt axis which has higher torque applied to it by the load.

4.6.2 In-Motion Power Mode

Description

Set and query the current level applied to axis motors when in-motion (in-transit).

Syntax

Query pan move power mode:	PM<delim>
High pan move power mode:	PMH<delim>
Regular move hold power mode:	PMR<delim>
Low pan move power mode:	PML<delim>
Query tilt move power mode:	TM<delim>
High tilt move power mode:	TMH<delim>
Regular tilt move power mode:	TMR<delim>
Low tilt move power mode:	TML<delim>

Example

```

PM * Pan in REGULAR move power mode
PML *
PM * Pan in LOW move power mode

```

Related Topics

- It is not recommended that an axis be in transit more than half the time when in High Move Power Mode (*i.e.*, a 50% duty cycle).

4.7 Host Serial Port and Control

As was described in Section 3, default host computer communications with the pan-tilt controller is 9600 baud. Host computer communications can be via RS-232, or as described in Section 7 it can be via the built-in RS-485.

Host serial port baud rates can be modified from the default. Also, a character delay may be specified for applications that cannot consume pan-tilt output rapidly enough.

4.7.1 Configuring Host Serial Port Baud and Communications

Description

Command specifies the baud rate for the host serial port RS232/RS485 communications with the pan-tilt controller. Only baud rate can be modified. The pan-tilt controller RS232/485 communications always use 1 start and stop bit, 8 data bits and no handshaking. The command also allows a transmission delay to be placed between bytes output by the pan-tilt controller.

The host serial port command in this Section 4.7.1 is only available when the controller is not networked (*i.e.*, the unit ID is the default of 0). ***When the controller is networked (i.e., unit ID is greater than 0), the host serial port communications rate is automatically set to the default and it cannot be modified by this command:*** the default is 9600 baud, 8 data bits, 1 start and stop bit, no parity, no handshaking, and no byte transmission delay. This ensures that networked controllers will *always* communicate at the same baud rate, and that higher data rates will not unduly burden pan-tilt controller processors.

Syntax

```
@(<baud>,<byte delay in msec>,<startup default>)<delim>
```

where:

<baud> may be 600, 1200, 2400, 4800, 9600, 19200 or 38400 bits/sec

<byte delay in msec> is the time in milliseconds the pan-tilt controller waits between transmitting output data. If no delay is desired, use a parameter of 0, otherwise, the delay may vary from 10 ms to 1000 ms.

<startup default> If T, <baud> and <byte delay in msec> are applied at power up; otherwise, the power up default is 9600 baud with no byte transmission delay.

Example

The following command sets the host serial port RS232/RS485 to a baud rate of 38,400 bits/second (8 data bits per byte, no parity, no handshaking), no delay in controller outbound byte transmission, and the power up baud rate is the system default of 9600 baud.

```
@(38400,0,F) *
```

The following command sets the host serial port RS232/RS485 to a baud rate of 19,200 bits/second (8 data bits per byte, no parity, no handshaking), a 30ms delay between bytes output from the pan-tilt controller, and the power up baud rate overrides the default and is set at 19,200 baud.

```
@(19200,30,T) *
```

Related Topics

- To wire the host port serial RS232 communications : See Section 3.2
- To wire the host port serial RS485 communications : See Section 7.2
- To set the pan-tilt controller unit ID : See Section 7.3.1

4.8 Step Modes

4.8.1 Configuring Step Mode

Description

The default motion resolution of the D46 controller is half step mode (0.9 degrees per motor step). Firmware versions 2.12.8 and higher added microstepping in quarter and eighth steps. Microstepping provides much quieter operation and smoother motion at slow speeds. In addition, the microstepping increases the effective resolution of the pan-tilt unit.

Firmware versions 2.13.0 and higher added autostep electronic gearing. The controller will automatically select the correct step mode based on the pan-tilt's current speed, and process all units as though the unit were in eighth step mode (0.006 degrees per motor step) while allowing the unit to move at the higher speeds of half step (up to 50 deg/sec).

Syntax

```
W<axis><resolution> where
  <axis> ::= T | P
  <resolution> ::= F | H | Q | E | A
for Full, Half, Quarter, Eighth and Auto step
resolution.
```

Example

The following command puts the tilt axis into eighth step resolution and recalibrates the tilt axis, which returns success (*).

```
WTE *
```

Known Issues

- Autostep mode is only supported in firmware versions v2.13.0 and higher. This firmware slow support querying the microstep mode with the “W<axis><delimiter>” command.
- Microstepping decreases the pull-out torque of the motor.
- For standard PTU-D46-70* units, microstepping on the pan axis is currently limited to Quarter step mode, as Eighth/Auto step resolution would exceed the current firmware integer representation for pan position.

5 SPECIAL CONFIGURATIONS

5.1 High-Speed Operation

This section discusses how to improve high speed pan-tilt unit performance for your load. The primary factors that affect high speed operation are:

- Load weight, weight distribution and dynamics
- Desired upper speed limit (see Section 4.4.6)
- Rate of acceleration (see Section 4.4.4)
- The base (start-up) speed (see Section 4.4.5)
- The voltage of the source power supply. Use of the highest available voltage in the range 9-30VDC significantly improves axis speed and acceleration performance.
- The in-motion power mode (see Section 4.6.2) and stationery power mode (see Section 4.6.1).
- Multiaxis dynamics. Simultaneously moving the tilt and pan axes affects the forces exerted on the pan axis.

High speed operation tests should always begin on each axis in isolation. When the best performance for each axis in isolation is understood, high speed operation of simultaneous pan-tilt axis movements can be performed.

An example configuration string for high speed operations is:

```
PA9000 PU6000 TA9000 PU6000 DS
```

5.2 High-Payload Operation

This section discusses how to improve high payload weight operation of the pan-tilt. The payload factors listed in the previous section outlined factors that affect payload carry capacity.

The primary factor affecting payload capacity is the tilt axis, as it is a lever which is an efficient force multiplier. The primary means to increase payload capacity are:

- Configure the pan-tilt controller for maximum torque. An example configuration string to maximize payload capacity is:

```
PU2000 PA2000 PB60 TU2000 TA2000 TB60 PMR TMR %%1R600 DS
```

 If your move duty cycle is less than 50%, you can alternatively use the highest move current settings and regular hold power settings of `PMH TMH PHR THR` .
- Move the payload center of gravity closer to the tilt axis
- Use a higher voltage power source in the range 9-30VDC
- Use the PTU-D46-70 which has a higher payload rating than the PTU-D46-17
- Determine if the payload can be modified to lighten it.

5.3 Battery-Powered Operation

The Pan-Tilt Unit and Controller have been designed for battery powered operation. Battery powered applications need to conserve power when possible. The pan-tilt unit has commands to control pan-tilt motor power consumption while in transit and when stationery (see Sections 4.6.1 and 4.6.2). Careful testing can be used to determine the lowest power modes that assure your load can be moved and held without losing synchrony (see Section 3.5).

6 PTU OPTIONS

6.1 EIO Option: Expansion Serial Ports and Control

In many cases, other serial devices are attached or proximal to the pan-tilt. In these cases, you can directly connect these other devices to your host computer serial ports. Doing this requires more serial ports on your host computer, and additional serial cabling is required. To reduce the host computer port and cabling requirements, an option for the PTU Controller is provided which adds two additional serial ports to the PTU controller.

A *mouse* or *trackball* can be connected to one of the expanded serial ports to allow direct user control of pan-tilt position without requiring an external host computer.

A PTU controller with additional serial ports may be identified by the two DB9 male connectors on the controller housing, and the firmware version number will include a “/D” (see Section 4.5.5 for querying PTU firmware). These additional RS232C DTE ports are designated Channel A (CHA) and Channel B (CHB).

The serial port expansion channels are controlled from the main PTU controller serial port. CHA/CHB RS232C ports may be configured from the PTU controller serial port to set expanded port baud rate, data bits, parity, and handshaking. Each channel operates independently, and the PTU controller fully buffers bi-directional data flow to allow for communications rate mismatch. Point-to-point communications between the PTU controller serial port and an expansion channel (e.g., CHB) is initiated by the host computer. Point-to-point communications is broken upon command from the host computer.

Communications from a serial device attached to an expansion serial channel is buffered (at least 200 characters). When hardware handshaking is not used, this buffer can overflow, so care should be taken to ensure that attached devices do not exceed the buffer size before its data on the serial channel is read by the host computer.

6.1.1 Select Serial Communications Target

Description

Command establishes point-to-point communications between the host computer connected to the PTU controller serial port and the expanded serial port (CHA/ CHB) or pan-tilt controller. When an expansion port channel is selected, the host computer is no longer communicating with the PTU controller, but instead with the external device connected to the expanded serial port. To resume communicating with the PTU controller, the host computer need only issue a command selecting the PTU controller as its desired communications target.

The baud rate of an expansion port does not affect the communications with the serial port connecting the host computer to the pan-tilt controller (which defaults to 9600 baud).

Syntax

```
Establish communications with CHA:      @A<delim>
Establish communications with CHB:      @B<delim>
Resume communications with the PTU controller: @<delim>
```

The modified commands below ensure that <# raw bytes> bytes will be passed directly from the host computer to the expanded serial port without any attempt to change the communications target. This allows strings like @B to be embedded in communications between the host computer and the expanded serial port device, without causing communications between the two to be inadvertently interrupted.

Establish communications with CHA: **@A<# raw bytes><delim>**
 Establish communications with CHB: **@B<# raw bytes><delim>**

where **<# raw bytes>** is the number of bytes to follow that will be received from the host computer which will not be scanned for changes in the serial communications target.

Example

```
@ *
PP * Current pan position is 0
@A *
This text is sent directly to the serial device on CHA
@B *
This text is sent directly to the serial device on CHB
@A20 *
This @B text is sent to CHA without choosing CHB
@ *
PP * Current pan position is 0
```

Related Topics

- To set expanded serial port communications parameters: See Section 6.1.1

6.1.2 Configuring Expanded Serial Port Communications

Description

Command specifies the communications parameters for an expanded serial port RS232C communications. These commands only affect the serial data rates for the expansion port connected to the external serial device; the PTU controller serial port default communicates at 9600 baud, 8 databits, no parity, and no handshaking. See section 4.7 for modifying host port communications speed.

Syntax

```
@A(<baud>,<databits>,<parity>,<handshaking>)<delim>
@B(<baud>,<databits>,<parity>,<handshaking>)<delim>
```

where **A** and **B** indicate RS232C expansion port CHA and CHB, and:

<baud> may be 300, 1200, 2400, 4800, 9600 or 19200 bits per second

<databits> may be 7 or 8 databits per byte

<parity> is case insensitive and may be **N** (none), **E** (even), or **O** (odd)

<handshaking> is case insensitive and may be **N** (none), **H** (hardware handshaking), **X** (XON/XOFF software handshaking), or **F** (both hardware/software handshaking)

Example

The following command sets the expansion serial port channel CHA to a baud rate of 9,600 bits/second, 8 data bits per byte, no parity, and no handshaking:

```
@A(9600,8,N,n) *
```

The following command sets the expansion serial port channel CHB to a baud rate of 19,200 bits/second, 8 data bits per byte, no parity, and hardware handshaking:

```
@B(19200,8,n,H) *
```

Related Topics

- To communicate with an expansion serial port channel : See Section 6.1.1

6.1.3 Attaching a Mouse/Trackball to an Expanded Serial Port

Description

A mouse or trackball can be connected to one of the expanded serial ports to allow direct user control of pan-tilt position without requiring an external host computer. When a host computer and mouse/trackball are both attached and enabled, the most recent pan-tilt movement command is processed. The host computer can control when the mouse/trackball is enabled, and the host can query the pan-tilt position while the pan-tilt is actively being controlled by the mouse/trackball.

Any Microsoft format compatible mouse or trackball can be used. These devices default the communications to be 1200 baud, 7 bits per character, no parity and hardware handshaking (which powers the device).

The default is for mouse/trackball control is enabled for CHA. If the mouse/trackball is enabled for both CHA/CHB expansion ports, only the CHA port will be used to effect pan-tilt control. A Default Save (see Section 4.5.2) will restore this state at power-up. Whenever expansion port communications are modified using the commands in Section 6.1.2, mouse/trackball control is disabled; the command in this section must be used to reenable mouse/trackball control.

Syntax

```
@A(M)<delim>
```

```
@B(M)<delim>
```

where **A** and **B** indicate RS232C expansion port CHA and CHB. **@A(M)** is the system default.

Example

```
PH * Pan in LOW hold power mode
```

```
@A(M) *
```

```
DS *
```

Configures the pan-tilt controller to look for a mouse/trackball on the CHA expansion port. After power up,

V * Pan-Tilt Controller v2.12.1d1(C14/EM), (C)2003 Directed Perception, Inc., All Rights Reserved

where “/EM” indicates the presence of the *EIO* option and the detection of a *Mouse/trackball*.

Related Topics

- To change expansion serial port communications : See Section 6.1.2

6.1.4 Expansion Analog Joystick Control Port and Pin-Out

The PTUC-EIO provides an analog joystick control port using a DB15 female receptacle. Directed Perception offers an analog joystick for use with this EIO port (model PT-EIO-JOY-DB).

A digital mouse/trackball using the EIO serial ports, described above, is superior to analog voltage controls, though an analog voltage control option is provided for those applications in which voltage control is required. The wiring diagram for the analog voltage control port is shown in Figure 5. X controls the pan axis and Y controls the tilt axis. X=0VDC is maximum pan left, and X=5VDC is maximum pan right. Similarly, Y=0 is maximum tilt down, and Y=5VDC is

maximum tilt up. For both axes, about 2-3VDC is a deadband in which no axis movement occurs; this accommodates for slight inaccuracies in the joystick, its home position, and internal A/D conversion.

If you wire your own analog joystick port input, use the 5VDC supplied by the controller. Do **not** supply your own 5VDC. **A voltage outside the range of 0-5VDC to the joystick will damage the internal A/D converter and void the warranty. Ensure your voltage controls stay within the required voltage range.**

A standard IBM PC compatible joystick may be rewired to function with the EIO analog joystick port. Analog PC joysticks are actually wired as variable resistors rather than potentiometers. (Historically, this is because A/D converters were expensive when the PC joystick was designed, so they kludged a shift register to do the job.) Figure 5 shows how to rewire a standard analog PC joystick to operate with the EIO option analog joystick port. Essentially, the rewire converts the variable resistor into a 100K potentiometer, and switch 2 is grounded so that the PTU controller can determine that a joystick is attached.

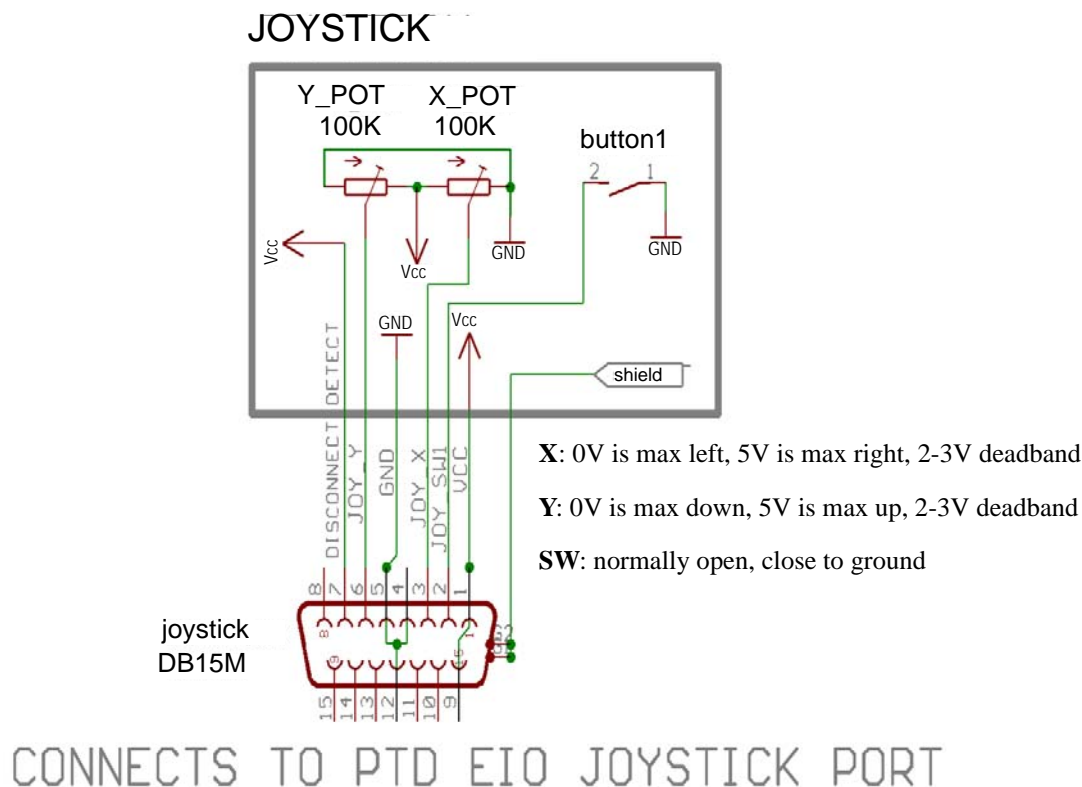

Figure 5. Wiring for the PTUC-EIO Analog Joystick Control Port

6.1.4.1 Expansion Analog Joystick Commands

Description

Two PTU controller commands were added to support the EIO joystick port to activate and deactivate it. When the joystick is centered in its X-Y range, no commands are sent to move the pan-tilt. Host computer serial PTU commands may be executed when the joystick is centered. When the joystick is moving, they override the most recent serial PTU commands. The joystick center range allows some position slop, called a deadband, to ensure that the

joystick is centered even when joystick values vary over time or movement. This deadband is about 20% of each joystick axis range. Outside the deadband, the joystick position is linearly related to speed of the pan and tilt axes. The fastest joystick speed is set by the lowest Upper Speed Limit for the pan and tilt axes. For example, for the command "PU6000 TU4000 ", the fastest joystick movement will be 4000 pos/sec. Note that if you change the Upper Speed Limit, you must issue a "JE " command for the new limit to affect joystick control speeds. In this way, you can control the joystick commanded speeds by setting desired Upper Speed Limits.

Syntax

JE<delim>	Enable EIO analog port joystick control
JD<delim>	Disable EIO analog port joystick control

Example

```
JE *  
DS *
```

Activates EIO analog port joystick control, and Default Saves so that joystick control is activated upon power up of the pan-tilt.

Related Topics

- To change pan-tilt axis upper speed bounds: See Section 4.4.6

7 NETWORKING

The PTU controller lets you connect up to 127 PTUs to a single host computer port. Your host computer can then address each PTU on the network as though the PTU were the only controller attached to the host. In this way, it is simple to migrate existing code developed for a single PTU to a network of PTUs controlled by a single host computer.

This section describes the basic installation and setup steps required to network your pan-tilt units.

7.1 Basic Networking Setup Steps

The steps in networking your PTU controllers to your host computer are:

1. Sketch out the physical placement of your PTU controllers and host computer.
2. Assign a unique network ID number to each PTU controller.
3. Connect the PTU controllers and host computer to the PTU network.
4. Test the configuration by addressing each PTU controller by its unit ID and commanding and querying its attached pan-tilt unit.

7.2 PTU Network Connections

Figure 6 illustrates how PTU controllers can be networked and connected to a host computer via its RS-232 port. Each PTU controller has a built-in RS-232 to RS-485 converter, and the host computer can be connected to the RS-485 controller network by simply connecting to the RS-232 connector on a PTU controller box. The PTU controllers are then connected together via an RS-485 multi-drop network (full duplex).

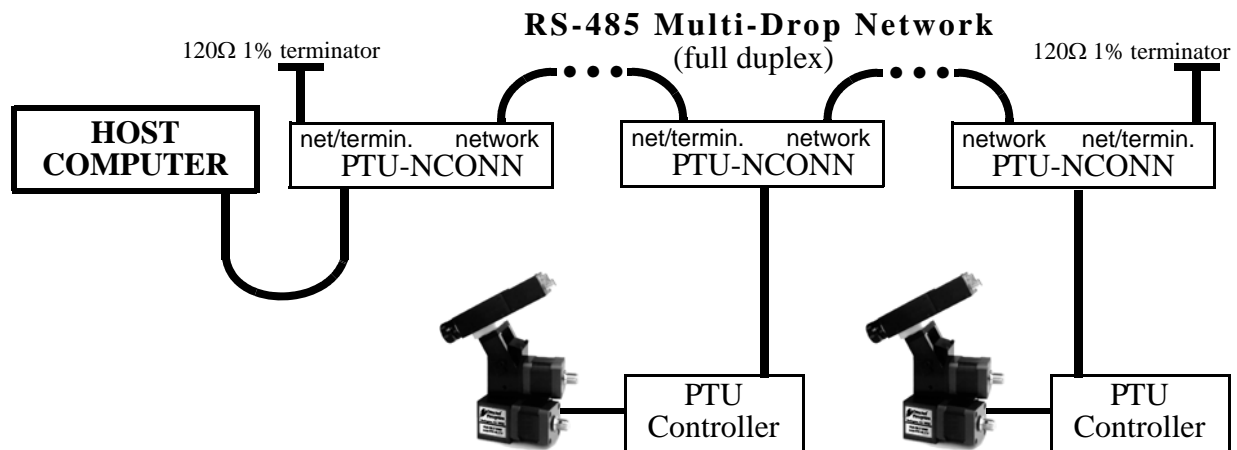

Figure 6: Making PTU Network Connections

The basic start configuration for networking PTU-controllers may be made using the PTU Network Starter Kit (model PTU-D46-NET-SK). This starter kit includes two Y-connectors used to connect to each of two PTU controllers, a data connection cable, and two network terminators. Additional PTU controllers may be networked using the PTU Network Addition Unit Kit (model PTU-D46-NET-AU), and this includes an additional Y-connector and data connector cable.

Figure 7 shows the wiring from the PTU RS-485 controller network receptacle (RJ-12, 6P6C). Several issues are important to note when you make your own data cables. First, use a

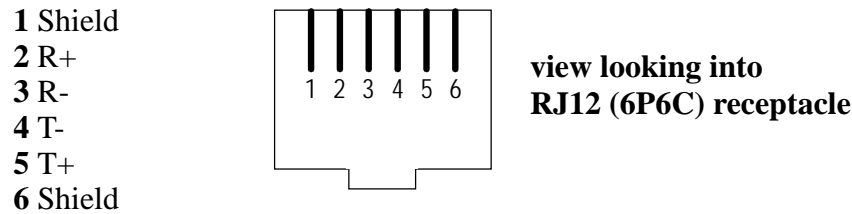

Figure 7: RS-485 Wiring

good quality cable. Though a good quality telephone cord cable can be used, use of a twisted pair cable is highly recommended. A twisted pair whose impedance is about 100Ω is typically used for longer RS-485 runs. The twisted pair provides good noise immunity owing to the relative signals used by the RS-485 standard.

For some applications, the host computer may directly provide RS-485 full-duplex I/O. In this case, you may use the RS-485 wiring diagram shown in Figure 7 to directly connect your host computer to the PTU controller network. For computers with only RS-232, RS-485 connections may be simply made using an external RS-232 to RS-485 converter. Directed Perception has tested/qualified two converters: ATEN IC-485S and Moxa A50 which both require a flipped RJ-12 connector (such as a standard phone cord). It is important to note that the network should be terminated using 120Ω 1% resistors to protect against signal ringing on the network. Termination is achieved by placing the resistors between the RS-485 Transmit+/Transmit- and Receive+/Receive- wires at each end of the multidrop wiring network.

7.3 PTU Network Software Commands

This section describes the pan-tilt command set used to configure, set and query the network configuration of your PTU controllers.

7.3.1 Unit Network ID

Description

Specify or query the PTU controller network unit ID number. By default, the PTU unit ID is set to zero which indicates the PTU controller is not networked, and the PTU controller is in the default interactive communications mode. When assigning a unit ID number to a controller, the unit ID number should be unique, the controller should be the only PTU controller attached to the host computer or terminal (otherwise other controllers may be set to the same unit ID number). A unit ID of zero may be used to put a PTU controller back in interactive (non- networked) mode.

Syntax

Query current PTU network unit ID:	U<delim>
Set PTU to interactive mode (non-networked):	U0<delim>
Set PTU network unit ID:	U<unit_ID><delim>
where $1 \leq \text{<unit_ID>} \leq 127$	

Example

The following queries a PTU unit ID, then sets and stores the unit ID configuration so that upon power-up the new unit ID will be used.

```
U * Unit ID is 0
U1 *
U * Unit ID is 1
U1 *
DS *
```

Related Topics

- Unit Select/Deselect: See Section 7.3.2.

7.3.2 Unit Select/Deselect**Description**

Command is used to select the PTU to be controlled. A PTU controller will execute incoming host computer commands only when the preceding unit_ID selected by the host is (a) equal to the PTU controller's assign unit ID, or, (b) equal to 0. A host computer can broadcast instructions to be executed by all PTO controllers using unit_ID=0. Only one PTU controller can provide feedback to the host computer at a time. A PTU controller provides feedback to the host computer only when the host computer has selected its unit ID. A PTU controller buffers its outgoing data until the host computer polls it -- the current PTU controller buffer size is about 100 bytes.

Syntax

Select a PTU controller for bi-directional data: `_<unit_ID><delim>`
 Broadcast to all networked PTU controllers: `_0<delim>`
 where $0 \leq \text{<unit_ID>} \leq 127$

Example

```
_1
pp300 *
_0
pp300
_1
*
```

Related Topics

- Unit Network ID: See Section 7.3.1.

A. SPECIFICATIONS

A.1 Pan-Tilt Mechanical Dimensions

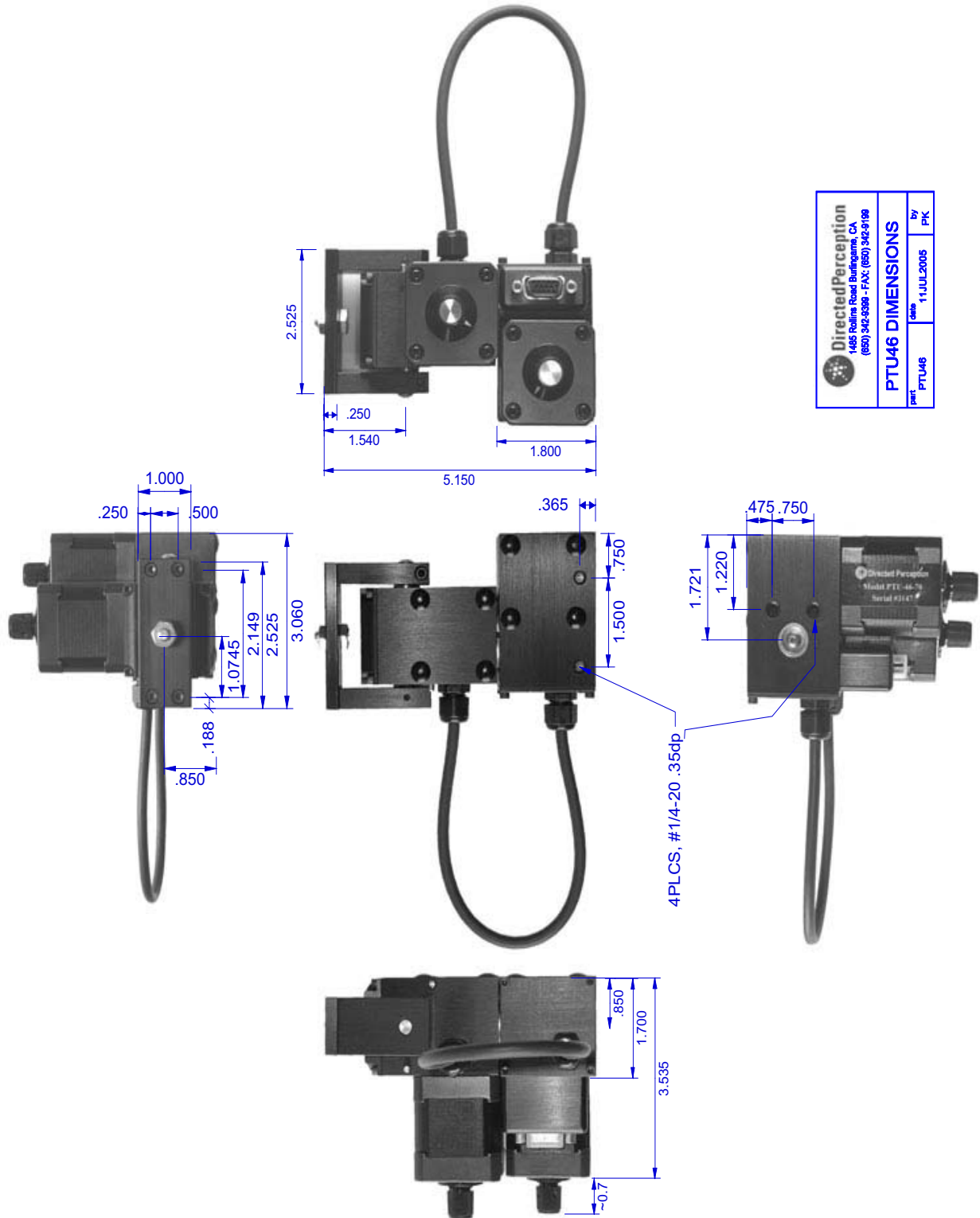

A.2 D46 Controller Dimensions

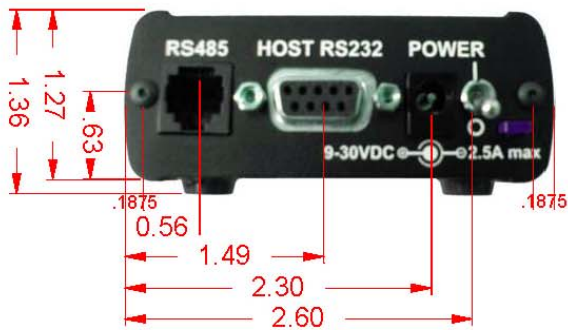
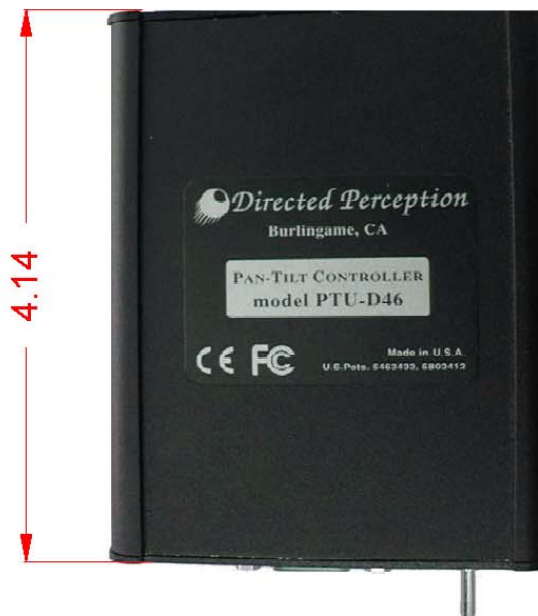
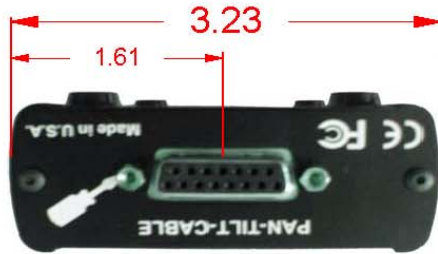

Directed Perception, Inc.

1485 Rollins Road Burlingame, CA
(650) 342-9399 - FAX: (650) 342-9199

PTU-D46 DIMENSIONS

part	date	by
PTU-D46r4	7/30/2003	PK

REGULATORY INFORMATION

Electromagnetic Interference (EMI) is any signal or emission, radiated in free space or conducted along power or signal leads that engenders the function of a radio navigation or other safety service or seriously degrades, obstructs, or repeatedly interrupts a licensed radio communications service.

Class A

Class A equipment has been tested and found to comply with the limits for a Class A digital device, pursuant to Part 15 of the FCC Rules. These limits are designed to provide reasonable protection against harmful interference in a commercial environment. This equipment generates, uses and can radiate radio frequency energy and, if not installed and used in accordance with the instructions, may cause harmful interference to radio communications. However, there is no guarantee that interference will not occur in a particular installation. Operation of this equipment in a residential area is likely to cause harmful interference, in which case the user will be required to correct the interference at his/her own expense.

All Directed Perception products have been tested to comply with FCC Class A requirements.

Class B

Class B equipment has been tested and found to comply with the limits for a Class B digital device, pursuant to Part 15 of the FCC Rules. These limits are designed to provide reasonable protection against harmful interference in a residential installation. This equipment generates, uses and can radiate radio frequency energy and, if not installed and used in accordance with the instructions, may cause harmful interference to radio communications. However, there is no guarantee that interference will not occur in a particular installation. If this equipment does cause harmful interference to radio or television reception, which can be determined by turning the equipment off and on, the user is encouraged to try to correct the interference by one or more of the following measures:

- Reorient or relocate the receiving antenna.
- Increase the separation between the equipment and receiver.
- Connect the equipment into an outlet on a circuit different from that to which the receiver is connected.
- Consult the dealer or an experienced radio/TV technician for help.

Directed Perception pan-tilt devices using a cable length of 7' or less, either with or without the EIO option, and using the PT-PS-INT30V power supply (including PT-PS-FERRITE) have been tested to comply with FCC Class B requirements.

Caution: Changes or modifications of this equipment not expressly approved by manufacturer could result in violation of Part 15 of the Federal Communications Commissions rules. The FCC has prepared the following booklet: "How to Identify and Resolve Radio-TV Interference Problems." It is available from the US Government Printing Office, Washington DC, 20402. Stock Number 004-00-00345-4.

FCC Notice

According to 47CFR, Parts 2 and 15, Class B Computer Peripherals:

This device complies with Part 15 of the FCC Rules. Operation is subject to the following two conditions: (1) This device may not cause harmful interference, (2) This device must accept any interference received including interference that may cause undesired operations.

LIMITED WARRANTY

Directed Perception, Inc. warrants this product against defects in material or workmanship, as follows:

For a period of one year from date of purchase, Directed Perception, Inc. will repair the defective product and provide new or rebuilt replacements at no charge. Warranty repairs require the issuance of a repair authorization number from Directed Perception prior to the return of merchandise, and the buyer assumes responsibility for freight charges.

After the one year period, you must pay for all parts, labor and freight.

This warranty does not cover any damage due to accident, misuse, abuse or negligence. You should retain your original bill of sale as evidence of the date of purchase.

REPAIR OR REPLACEMENT AS PROVIDED UNDER THIS WARRANTY IS THE EXCLUSIVE REMEDY OF THE PURCHASER. DIRECTED PERCEPTION SHALL NOT BE LIABLE FOR ANY INCIDENTAL OR CONSEQUENTIAL DAMAGES FOR BREACH OF ANY EXPRESS OR IMPLIED WARRANTY ON THIS PRODUCT, EXCEPT TO THE EXTENT PROHIBITED BY APPLICABLE LAW, ANY IMPLIED WARRANTY OF MERCHANTABILITY OR FITNESS FOR A PARTICULAR PURPOSE ON THIS PRODUCT IS LIMITED IN DURATION TO THE DURATION OF THIS WARRANTY.

Some states do not allow the exclusion or limitation of incidental or consequential damages, or allow limitations on how long an implied warranty lasts, so the above limitations or exclusion may not apply to you. This warranty gives you specific legal rights, and you may also have other rights which vary from state to state.